

SOFFIANTI A CANALI LATERALI

Side channel blowers



ESC401T0.85

Le curve sono il risultato di test effettuati a pressione atmosferica e temperatura di 15°C. La tolleranza è di $\pm 10\%$.

The performance curves are tested under atmospheric pressure and air temperature at 15°C. The tolerance is $\pm 10\%$.

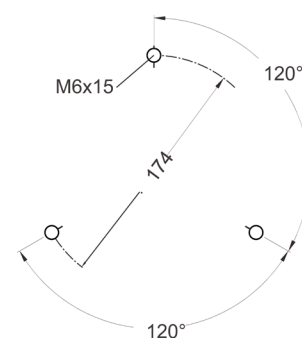
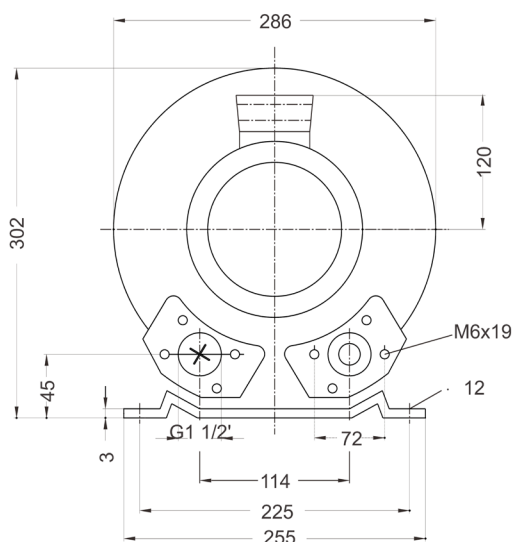
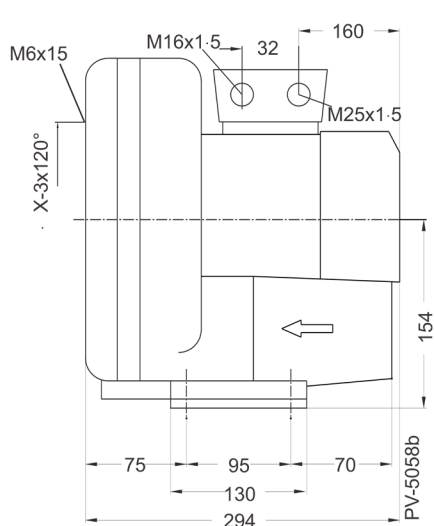
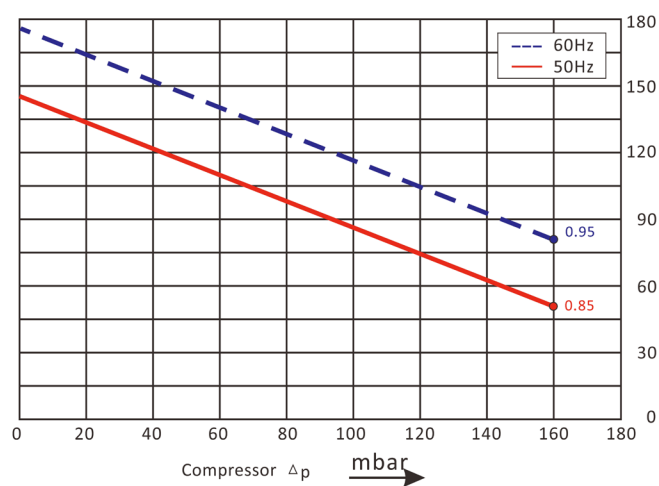
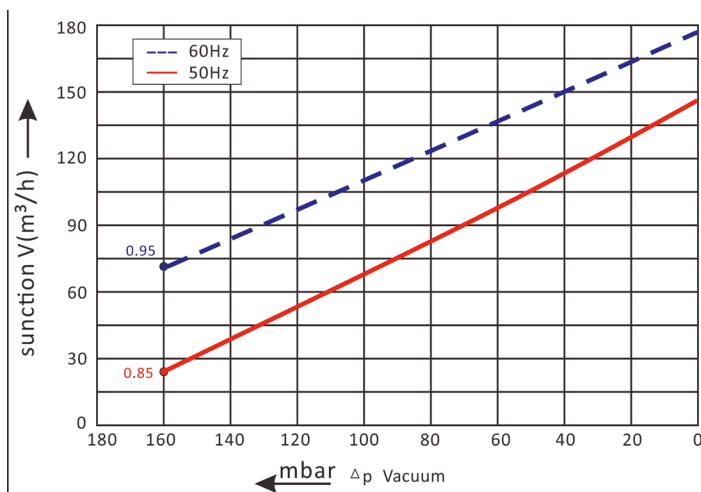

CURVA Curve (n.)	MODELLO Model	FREQUENZA Frequency (Hz)	POTENZA Power (kW)	VOLTAGGIO Voltage (V)	ASSORBIMENTO Current (A)	RUMOROSITÀ Noise (dB)	PESO Weight (Kg)
1	ESC401T0.85	50	0.85	200-240Δ 345-415Y	4.2Δ/2.4Y	63	15
2	ESC401T0.85	60	0.95	220-275Δ 380-480Y	4.0Δ/2.3Y	64	15