

autosen

AUTOMATION & SENSORS



Operating instructions
Electronic level sensor

UK

autosen **AF004**



80259948 00 12/2016

Made in Germany

Contents

1 Preliminary note.....	4
1.1 Symbols used	4
2 Safety instructions	4
3 Items supplied.....	5
4 Functions and features	7
4.1 Operation with single probe.....	7
4.2 Operation with coaxial probe	7
4.3 Applications	8
4.3.1 Restriction of the application area	8
5 Function.....	9
5.1 Measuring principle	9
5.2 Features of the unit.....	10
5.2.1 Easy set-up.....	10
5.2.2 Display functions	10
5.2.3 Switching functions.....	10
5.2.4 Offset for indicating the real level in the tank.....	11
5.2.5 Probes for different tank heights.....	11
5.2.6 Safe state	12
5.3 IO-Link	12
6 Installation.....	13
6.1 Installation location / environment	13
6.1.1 Unit with single probe	13
6.1.2 Unit with coaxial probe	16
6.2 Installation of the probe	16
6.2.1 Installation of the rod	17
6.2.2 Installation of the coaxial pipe	18
6.3 Shortening of the probe	19
6.3.1 How to shorten the rod and determine its length L.....	19
6.3.2 Shortening of the coaxial pipe	19
6.3.3 Determination of the rod length L when coaxial probes are used.....	20
6.4 Installation of the unit with single probe.....	20
6.4.1 Installation in closed metal tanks (without flange plate)	21
6.4.2 Installation in closed metal tanks (with flange plate)	21
6.4.3 Installation in open tanks	22

6.4.4	Installation in plastic tanks.....	23
6.5	Installation of the unit with coaxial probe in the tank.....	23
6.6	Alignment of the sensor housing.....	24
7	Electrical connection.....	24
8	Operating and display elements.....	25
9	Menu.....	26
9.1	Menu structure.....	26
9.2	Explanation of the menu.....	27
10	Parameter setting.....	28
10.1	Parameter setting in general.....	28
10.2	Basic settings (unit on delivery).....	30
10.2.1	Entering the probe length.....	30
10.2.2	Setting to the medium.....	30
10.2.3	Entering the type of probe used.....	30
10.3	Configuration of the display.....	31
10.4	Offset setting.....	31
10.5	Setting of output signals.....	31
10.5.1	Setting of the output function.....	31
10.5.2	Set the switching limits (hysteresis function).....	31
10.5.3	Set the switching limits (window function).....	32
10.5.4	Setting of the switch-off delay.....	32
10.5.5	Response of the outputs in case of a fault.....	32
10.5.6	Setting of the delay time after signal loss.....	32
10.6	Reset all parameters to factory setting.....	32
10.7	Changing basic settings.....	33
10.7.1	Re-enter the probe length.....	33
10.7.2	Setting to another medium.....	33
10.7.3	New entering of the type of probe used.....	33
11	Operation.....	34
11.1	Operating indicators.....	34
11.2	Read the set parameters.....	34
11.3	Changing the display unit in the Run mode.....	34
11.4	Error indications.....	35
11.5	Output response in different operating states.....	36
12	Technical data and scale drawing.....	36
12.1	Setting ranges.....	36

UK



13 Servicing	37
14 Applications.....	38
14.1 Minimum level monitoring with early warning and alarm	38
14.2 Pumping station / empty the tank with overflow protection.....	39
14.3 Storage tank	40
15 Factory setting	41

1 Preliminary note

1.1 Symbols used

- ▶ Instructions
- > Reaction, result
- [...] Designation of keys, buttons or indications
- Cross-reference



Important note

Non-compliance may result in malfunction or interference.



Information

Supplementary note.

2 Safety instructions

- Please read this document prior to set-up of the unit. Ensure that the product is suitable for your application without any restrictions.
- If the operating instructions or the technical data are not adhered to, personal injury and/or damage to property can occur.
- Improper or non-intended use may lead to malfunctions of the unit or to unwanted effects in your application. That is why installation, electrical connection, set-up, operation and maintenance of the unit must be carried out by qualified personnel authorised by the machine operator.
- In order to guarantee the correct operation of the unit, it is necessary to use the unit in media to which it is sufficiently resistant (→ Technical data).





- The responsibility as to the suitability of the unit for the application lies with the operator. The manufacturer assumes no liability for consequences of misuse by the operator.
- Improper installation and use of the unit result in a loss of the warranty claims
- The unit may cause radio interference in domestic areas. If interference occurs, the user must take appropriate remedial actions.
- The unit complies with the standard EN 61000-6-4 and is a class A product. The radiated energy of the microwaves is, for example, much below that of mobile phones. According to the current state of science the operation of the unit can be classified to be harmless to human health.

UK

3 Items supplied

- Level sensor AF004
- Operating instructions

In addition, the following is necessary for installation and operation:

- 1 rod (for operation of the unit with single probe → 4.1)
- plus 1 coaxial pipe (for operation of the unit with coaxial probe → 4.2)
- mounting material (if necessary, a launching plate → 4.1)



The following components are available as accessories:

Rods	Length (cm / inch)	Order number
	45 / 17,7	AA926
	70 / 27,6	AA927
	100 / 39,4	AA928
	160 / 63.0	AA944

Coaxial pipes with process connection G $\frac{3}{4}$	Length (cm / inch)	Order number
	45 / 17.7	AA929
	70 / 27.6	AA930
	100 / 39.4	AA931
	160 / 63.0	AA945

Flange plates	Size / process connection	Order number
	73 - 90 / G $\frac{3}{4}$	AA941
	65 - 80 / G $\frac{3}{4}$	AA942



Only use rods and coaxial pipes from autosen gmbh. The optimum function is not ensured when using components from other manufacturers.

4 Functions and features

The unit continuously detects the level in tanks and generates output signals according to the parameter settings.

2 switching outputs are available. They can be set separately.

4.1 Operation with single probe

The single probe is made up of one individual rod. Operation with single probe is suited for the detection of aqueous media, in particular of heavily soiled aqueous media.



For the correct function when used with single probe, the unit needs a large enough metal launching plate. It is necessary for transferring the microwave pulse to the tank with optimum transmission power.

The flange plates that are available as accessories are not sufficient as launching plates (for suitable launching plates → 6.4).

For installation in closed metal tanks, the tank lid serves as a launching plate. For installation in open metal tanks, tanks made of plastic or metal tanks with plastic lids a sufficiently large fixing plate, a metal plate or similar must be used (→ 6.4.3 / → 6.4.4).

For operation with single probe, minimum distances to tank walls, objects in the tank, bottom of the tank and further level sensors must be adhered to (→ 6.1.1).

UK

4.2 Operation with coaxial probe

The coaxial probe is made up of an inner rod and an outer probe pipe (coaxial pipe). The rod is centred in the coaxial pipe by one or several spacers.

In case of operation with a coaxial probe media with a low dielectric constant (e.g. oil and oil-based media) are detected in addition to aqueous media.



No launching plate is required for operation with coaxial probe.

Furthermore, no minimum distances to tank walls and objects in the tank are required.

4.3 Applications

- Water, water-based media
- Oils, oil-based media (only for operation with coaxial probe)

Application examples:

- Detection of coolant emulsion in a machine tool.
- Detection of cleaning liquid in a parts cleaning system.
- Monitoring of hydraulic oil in a hydraulic power unit (only for operation with coaxial probe).

4.3.1 Restriction of the application area



Incorrect measurements or signal loss may be caused by the following media:

- Highly absorbing surfaces (e.g. foam).
- Intensely bubbling surfaces.
- Media which are very inhomogeneous, separate from each other thus forming separation layers (e.g. oil layer on water).
 - ▶ Check the function by performing an application test.
 - ▶ Installation in a steady area (→ 6.1).
 - > In case of signal loss, the unit displays [E.033] and switches the outputs to a defined state (→ 11.5).
- The unit is not suitable for bulk materials (e.g. plastic granulates).
- If the unit is to be used in acids or alkalis, in hygienic areas or in electroplating applications: first check the compatibility of the product materials (→ 12 Technical data and scale drawing) with the media to be monitored.
- The unit is not suitable for applications where the probe is subjected to permanent and high mechanical stress (e.g. strongly moving viscous media or strongly flowing media).
- In case of operation with single probe: use preferably in metal tanks. When installed in plastic tanks, deterioration caused by electromagnetic interference may occur (noise immunity according to EN61000-6-2).
Corrective measures: → 6.4.4.
- In case of operation with coaxial probe: not suitable for soiled or viscous media and media prone to formation of deposit.
Maximum viscosity: 500 MPa · s.

5 Function

5.1 Measuring principle

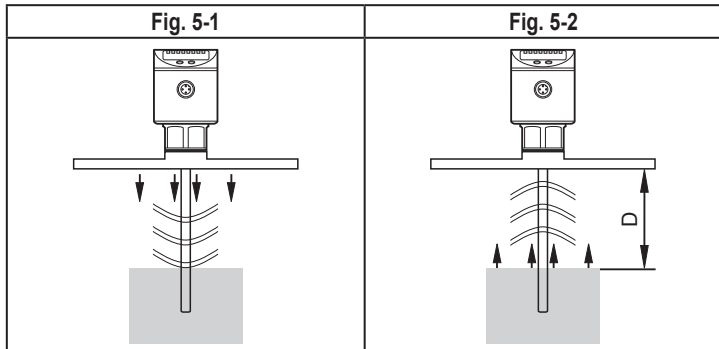

The unit operates to the principle of guided wave radar. It measures the level using electromagnetic pulses in the nanosecond range.

The pulses are transmitted by the sensor head and guided along the rod (fig. 5-1). When they hit the medium to be detected they are reflected and guided back to the sensor (fig. 5-2). The time between transmitting and receiving the pulse directly relates to the travelled distance (D) and the current level. The reference for distance measurement is the lower edge of the process connection.



The figures show operation with single probe. In case of operation with a coaxial probe, the guided wave runs only along the inside of the coaxial pipe.

5.2 Features of the unit

5.2.1 Easy set-up

- When the unit is supplied with operating voltage for the first time, the probe length, the medium to be detected and the type of probe used must be entered. Then the unit is ready for operation (→ 10.2).
- If necessary, parameters for the output signals and optimisation of the monitoring functions can be set (→ 10.3 to → 10.5).
- All settings can also be carried out before installation of the unit.
- Reset to the factory settings is possible.
- Electronic lock can be set to prevent unintentional operations.

5.2.2 Display functions

The unit displays the current level, either in cm, inch or in percent of the final value of the measuring range. Factory setting: cm. The display unit is defined by programming (→ 10.3). In the Run mode, it can be temporarily switched between length indication (cm / inch) and percentage:

▶ briefly press [Set].

> The selected unit is displayed for 15 s, the corresponding LED is lit. With each push of the button the display type is changed.

The set unit of measurement and the switching status of the outputs are indicated by LEDs.

5.2.3 Switching functions

The unit signals via two switching outputs OUT1 / OUT2 that a set limit level has been reached or that the level is below the limit value. For each output the following switching functions can be selected:

- Hysteresis function / normally open (fig. 5-3): [OUx] = [Hno].
- Hysteresis function / normally closed (fig. 5-3): [OUx] = [Hnc].



First the set point (SPx) is set, then the reset point (rPx) with the requested difference.

- Window function / normally open (fig. 5-4): $[OUx] = [Fno]$.
- Window function / normally closed (fig. 5-4): $[OUx] = [Fnc]$.



The width of the window can be set by means of the difference between FHx and FLx. FHx = upper value, FLx = lower value.

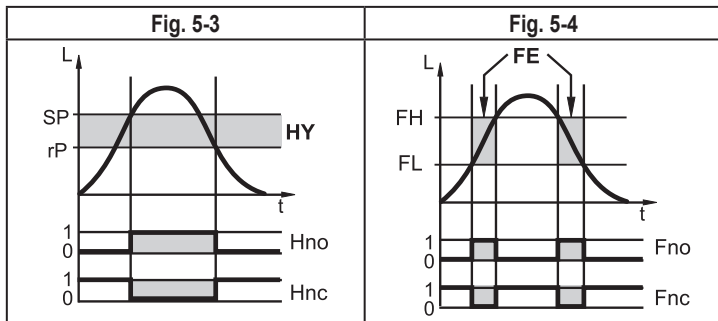

L = level; HY = hysteresis; FE = window

- For each switching output a switch-off delay of max. 60 s can be set (e.g. for especially long pump cycles).

5.2.4 Offset for indicating the real level in the tank

The zone between tank bottom and lower edge of the probe can be entered as offset value [OFS]. So display and switch points refer to the actual level.

5.2.5 Probes for different tank heights

- The unit can be installed in tanks of different sizes. Probes in different lengths are available. To adapt to the tank height, each probe can be shortened. The minimum probe length is 10 cm, the maximum probe length is 160 cm.
- Probe and housing can be rotated without restriction. This enables easy installation and orientation of the head of the unit after installation.

5.2.6 Safe state

- In case of a fault a safe state can be defined for each output.
- If a fault is detected or if the signal quality is below a minimum value, the outputs pass into the "safe state". For this case the response of the outputs can be set via the parameters [FOU1], [FOU2].
- Temporary loss of signal caused e.g. by turbulence or foam formation can be suppressed by a delay time (\rightarrow 10.5.6 [dFo]). During the delay time the last measured value is frozen. If the measured signal is received again in sufficient strength within the delay time, the unit continues to work in normal operation. If, however, it is not received again in sufficient strength within the delay time, the outputs pass into the safe state.



In case of heavy foam formation and turbulence, note the examples of how to create a steady area (\rightarrow 6.1.2).

5.3 IO-Link

General information

This unit has an IO-Link communication interface which requires an IO-Link-capable module (IO-Link master) for operation.

The IO-Link interface enables direct access to the process and diagnostic data and provides the possibility to set the parameters of the unit during operation. In addition communication is possible via a point-to-point connection with a USB adapter cable.

Further information about IO-Link is available at [www. .com](http://www.autosen.com).

Device-specific information

You will find the IODDs necessary for the configuration of the IO-Link unit and detailed information about process data structure, diagnostic information and parameter addresses at www.autosen.com.

Parameter setting tools

You will find all necessary information about the required IO-Link hardware and software at www.autosen.com.

6 Installation

6.1 Installation location / environment

- Vertical installation from the top is preferred.

6.1.1 Unit with single probe

- For a safe function, the unit requires a launching plate (→ 6.4).
- For optimum operation the unit is to be installed as near as possible to the tank wall. Distance between the rod and the tank wall: minimum 40 mm, maximum 300 mm.
- The following minimum distances between the rod and tank walls, objects in the tank (B), tank bottom and other level sensors must be adhered to:

UK

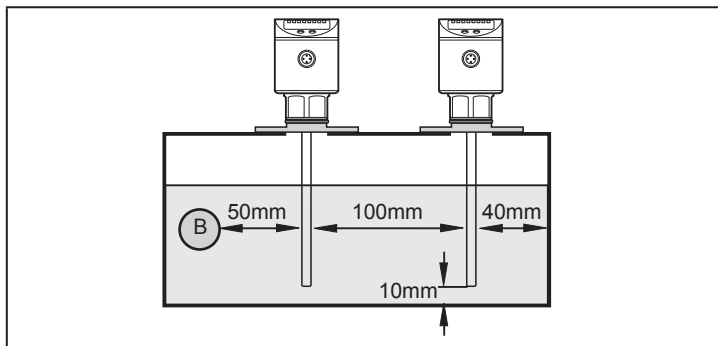

- For tank walls which are not straight, steps, supports or other structures in the tank a distance of 50 mm to the tank wall must be adhered to.
- For probe lengths > 70 cm the rod can be considerably deflected by movement of the medium. To avoid contacting the tank wall or other structures in the tank in such cases, the minimum distances should be increased.

Reference values:

Probe length	Distance to the tank wall or structures in the tank
70...100 cm	100 mm
100...160 cm	180 mm

- If the medium is strongly polluted, there is the risk that a bridge forms between the rod and the tank wall or structures in the tank. To avoid incorrect

measurements: adhere to increased minimum distances depending on type and intensity of the soiling.

- For installation in pipes:
 - The inside pipe diameter (d) must be at least 100 mm (fig. 6-1).
 - Only install the unit in metal pipes.
- For installation in connection pieces:
 - The diameter of the boss (d) must be at least 60 mm (fig. 6-2).
 - The height of the boss (h) must not exceed 40 mm (fig. 6-2).



Although the unit can be installed in a boss, installation in a flat tank lid is recommended. A boss will impede the distribution of the microwaves.

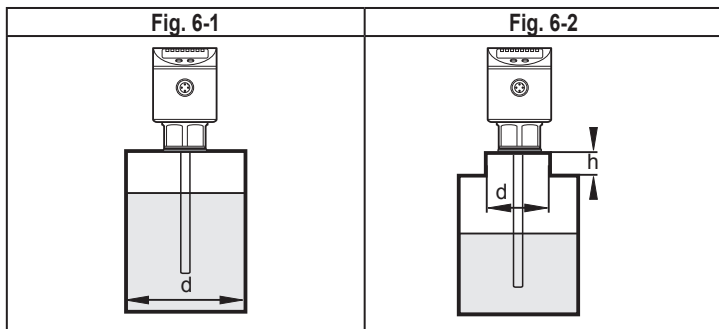

- Do not install the unit in the immediate vicinity of a fill opening (fig. 6-3).
If possible, install a fill pipe (A) in the tank (fig. 6-4). Minimum distance between the fill pipe and the rod = 50 mm; higher for probe lengths > 70 cm and in case of heavy soiling (→ 6.1.1).

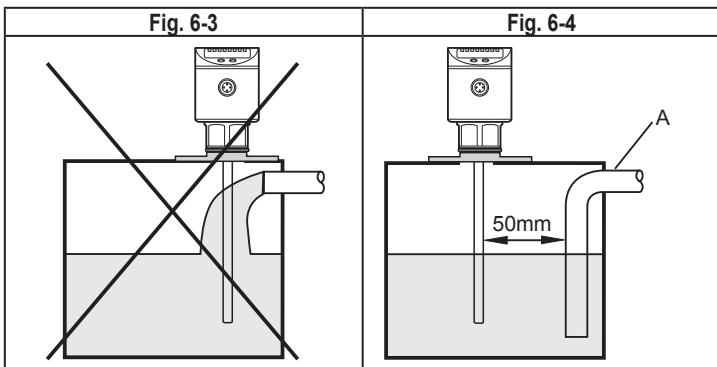

UK

- !** To avoid incorrect measurements in case of heavy foam formation and turbulence:
- ▶ if possible, install the sensor in a steady area.

Example how to create a steady area:

- Use of a coaxial probe (only for clean, low-viscosity media)
- Installation in bypass or still pipe (see fig. 6-5)
- Separation of the installation location by metal sheets / perforated sheets (without figure)

- !** Minimum diameter of the bypass and still pipe: $d = 100 \text{ mm}$.
 The upper access to the steady area (fig. 6-5: A / B) has to be above the maximum level. The lower access (fig. 6-5: C / D) or the area with perforated sheet etc. has to be below the minimum level. This ensures that neither foam nor turbulence impact the sensor zone. When perforated sheets or the like are used, soiling (e.g. by metal swarf, particles, ...) can also be avoided.

Fig.: 6-5

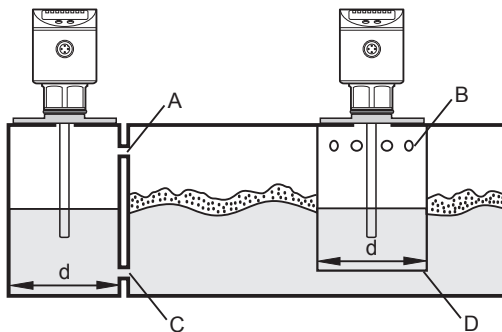

6.1.2 Unit with coaxial probe

- No minimum distances to the tank wall and the baffles (B) are required.
- Minimum distance to the bottom of the tank: 10 mm.
- The vent hole (A) must not be covered by mounting elements or similar.
- Do not install the unit in the immediate vicinity of a fill opening. No water jets must enter into the holes of the coaxial pipe.

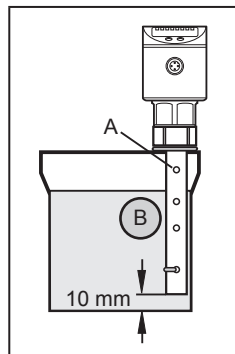

- Note in case of foam formation: the vent of the coaxial pipe must be above the maximum level. The lower edge of the coaxial pipe must be below the minimum level.

6.2 Installation of the probe

Rod and coaxial pipe are not included in the scope of delivery. They must be ordered separately (→ 3 Items supplied).

6.2.1 Installation of the rod

Fixing of the rod:

- Screw the rod to the unit and tighten it.



Recommended tightening torque: 4 Nm.

For ease of installation and removal the rod connection can be rotated without restriction. Even if rotated several times there is no risk of damage to the unit.

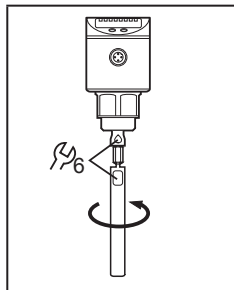

In case of high mechanical stress (strong vibration, moving viscous media) it may be necessary to secure the screw connection, e.g. by a screw retaining compound.



Substances such as screw retaining compounds may migrate into the medium.

Make sure that they are harmless.

When using mechanical means of securing (e.g. tooth lock washer), protruding edges must be avoided. They may cause interference reflection.

6.2.2 Installation of the coaxial pipe

This subchapter is only relevant if the unit is to be operated with a coaxial probe.



The coaxial pipe and the rod must be of the same end length. The coaxial pipe can be shortened (→ 6.3.2).

- ▶ Screw the rod to the unit and tighten it.
Recommended tightening torque: 4 Nm.
- ▶ Slide the sensor seal (A) onto the thread.
- ▶ Slide the coaxial pipe (B) onto the rod. Carefully centre it and carefully move the rod through the centring piece (C) (for lengths > 140 cm through both centring pieces) of the coaxial pipe. Do not damage the centring pieces.
- ▶ Screw onto the sensor thread and tighten.

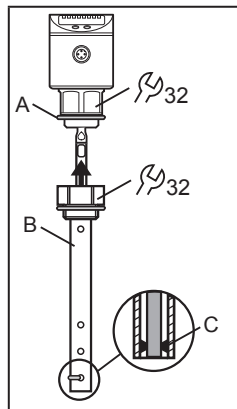

6.3 Shortening of the probe

6.3.1 How to shorten the rod and determine its length L

The rod can be shortened to adapt the probe to different tank heights.

! Ensure that the probe length is never below the minimum permissible probe length of 10 cm (L_{min})! The unit does not support probe lengths below 10 cm. If shorter probes are used, measurement errors can occur.

Proceed as follows:

- ▶ Screw the rod to the unit.
- ▶ Mark the desired length (L) on the rod. The reference point is the lower edge of the process connection.
- ▶ Remove the rod from the unit.
- ▶ Shorten the rod at the mark.
- ▶ Remove all burrs and sharp edges.
- ▶ Screw the rod to the unit again and tighten it. Recommended tightening torque: 4 Nm.
- ▶ Precisely measure the probe length L, note the value. It must be entered during parameter setting of the unit (→ 10.2).

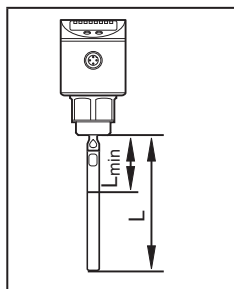

$L_{min} = 10 \text{ cm}$

6.3.2 Shortening of the coaxial pipe

The coaxial pipe and the rod must be of the same end length:

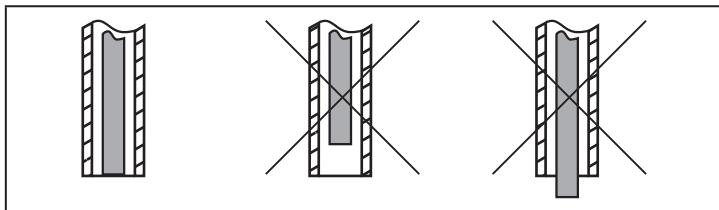

- ▶ Remove fastening bracket and centring piece (A, B).
- ▶ Shorten the coaxial pipe to the requested length: $L_K = L + 9 \text{ mm}$.
- ▶ After shortening, at least one hole (C) for insertion of the fixing bracket has to be left.
- ▶ Remove all burrs and sharp edges.
- ▶ Insert centring piece (A) at the lower end of the pipe and attach it using the fixing bracket (B) at the lower hole (C).

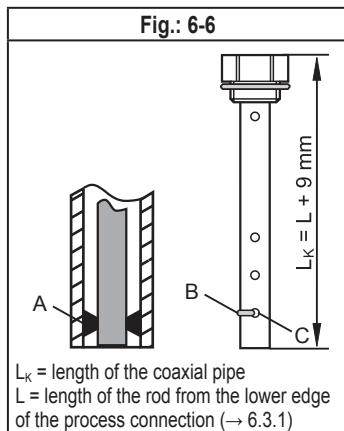

6.3.3 Determination of the rod length L when coaxial probes are used

Only relevant if the rod length L (→ 6.3.1) is unknown:

- ▶ Measure the exact total length L_K of the coaxial pipe (→ fig. 6-6, on the right).
- ▶ Deduct 9 mm from the total length of the coaxial pipe: $L_K - 9 \text{ mm} = L$
- ▶ Note down L . It must be entered during parameter setting of the unit (→ 10.2).

6.4 Installation of the unit with single probe

! For the correct function when used with single probe, the unit needs a large enough metal launching plate. It is necessary for transferring the microwave pulse to the tank with optimum transmission power. The flange plates that are available as accessories are not sufficient as launching plates.

For installation in closed metal tanks, the tank lid serves as a launching plate (R in fig. 6-7 and 6-11). 2 ways of installation are possible:

- Screw in a G $\frac{3}{4}$ process connection in the tank lid (→ 6.4.1).
- Installation in the tank lid using a flange plate, e.g. for tanks with thin walls (→ 6.4.2).

Furthermore, installation in open tanks (→ 6.4.3) and plastic tanks is possible (→ 6.4.4).

6.4.1 Installation in closed metal tanks (without flange plate)

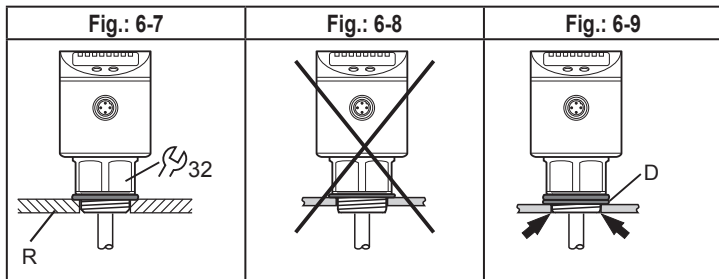

UK

- ▶ The lower edge of the process connection should be flush with the installation environment (fig. 6-7).
- ▶ Avoid non-flush installation (fig. 6-8).
- ▶ Use seals or washers (D in fig. 6-9) to reach the required height.
- ▶ For tanks with thick walls arrange for sufficiently deep recesses to ensure flush installation.

6.4.2 Installation in closed metal tanks (with flange plate)



Flange plates are not supplied. They must be ordered separately (→ 3 Items supplied).

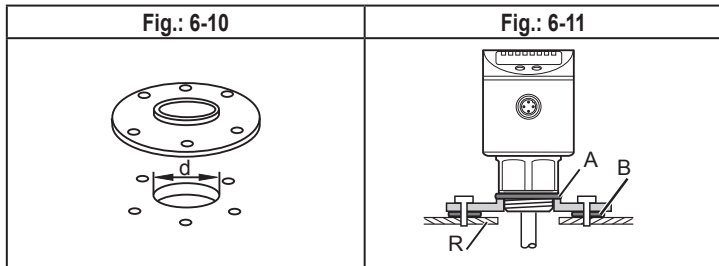

- ▶ Arrange for a bore hole in the tank lid. It must have a minimum diameter (d) to enable sufficient transfer of the measured signal to the probe (fig. 6-10). The diameter depends on the wall thickness of the tank lid:

Wall thickness [mm]	1...5	5...8	8...11
Bore hole diameter [mm]	35	45	55

- ▶ Install the flange plate with the flat surface showing to the tank and fix it with appropriate screws.

! A seal (B in fig. 6-11) can be inserted between flange plate and tank. Some flange plates are supplied with a seal.

- ▶ Ensure cleanness and evenness of the sealing areas; especially if the tank is under pressure. Tighten the fixing screws sufficiently.
- ▶ Screw the unit into the flange plate using the process connection and tighten firmly.
- ▶ Make sure that the supplied sensor seal (A in fig. 6-11) is correctly positioned.

6.4.3 Installation in open tanks

- ▶ For installation in open tanks, use a metal fixture to install the unit. It serves as a launching plate (R); minimum size: 150 x 150 mm for a square fixture, 150 mm diameter for a circular fixture.
- ▶ If possible, mount the unit in the middle of the fixture. The distance D2 must not be below 40 mm, higher for probe lengths > 70 cm and in case of heavy soiling (→ 6.1.1):

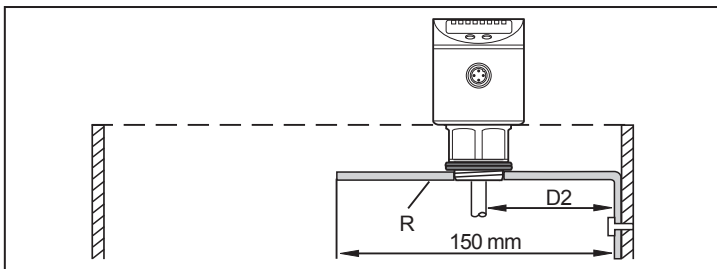

- ▶ The lower edge of the process connection should be flush with the installation environment (see fig. 6-7).
- ▶ Avoid non-flush installation (see fig. 6-8).
- ▶ Use seals or washers (see D in fig. 6-9) to reach the required height.

6.4.4 Installation in plastic tanks

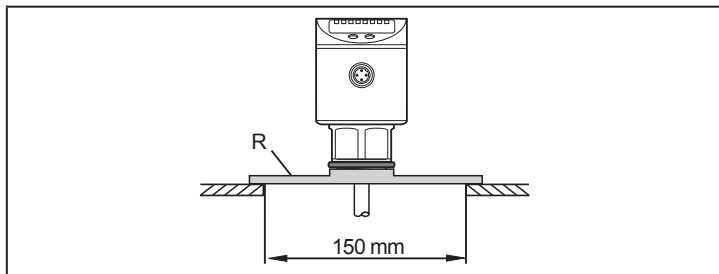

To enable sufficient transfer of the measured signal, note in case of installation in plastic tanks or metal tanks with plastic lid:

- ▶ A drill hole with a minimum diameter of 150 mm must be applied to the plastic lid.
- ▶ For installation of the unit, a metal flange plate (= launching plate R) must be used which sufficiently covers the drill hole.
- ▶ Ensure the minimum distance (= 80 mm) between rod and tank wall, higher for probe lengths > 70 cm and in case of heavy soiling (→ 6.1.1).

! When installed in plastic tanks, there may be deterioration caused by electromagnetic interference. Corrective measures:

- apply a metal foil to the outside of the tank.
- Apply a shielding screen between the level sensor and other electronic units.
- Operation with coaxial probe efficiently protects the unit from electromagnetic interference. Please note the restrictions regarding the application area (→ 4.3).

6.5 Installation of the unit with coaxial probe in the tank

- ▶ Seal the process connection:
 - For pipes with G $\frac{3}{4}$ process connection: slide the supplied seal onto the thread of the coaxial pipe.
- ▶ Screw the unit with the coaxial pipe into the tank and tighten it.

6.6 Alignment of the sensor housing



After installation, the sensor housing can be aligned. It can be rotated without restriction. Even if rotated several times there is no risk of damage to the unit.

7 Electrical connection



The unit must be connected by a qualified electrician.

The national and international regulations for the installation of electrical equipment must be adhered to.

Voltage supply according to EN 50178, SELV, PELV.

- ▶ Disconnect power.
- ▶ Connect the unit as follows:

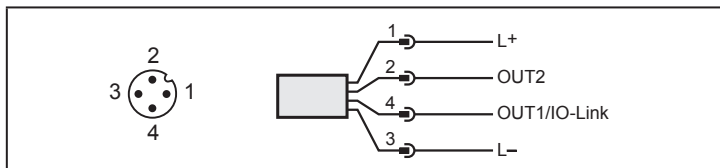

Pin	Connection	Core colours for autosen sockets
1	Ub+	brown
3	Ub-	blue
2 (OUT2)	pnp switching signal	white
4 (OUT1)	<ul style="list-style-type: none">• pnp switching signal• IO-Link	black



When the unit is supplied with operating voltage for the first time, the probe length, the medium to be detected and the type of probe used must be entered. Only then is the unit ready for operation (→ 10.2).

8 Operating and display elements

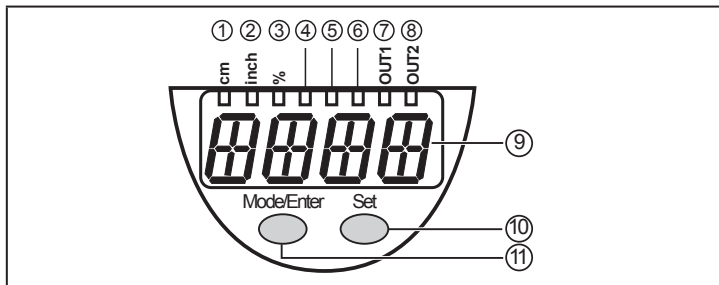

1 to 8: Indicator LEDs

- LED 1: green = indication of the level in cm.
- LED 2: green = indication of the level in inch.
- LED 3: green = indication of the level in % of the final value of the measuring range.
- LED 4 - LED 6: not used.
- LED 7: yellow = output 1 is switched.
- LED 8: yellow = output 2 is switched.

9: Alphanumeric display, 4 digits

- Indication of the current level.
- Operation and fault indication.
- Indication of the parameters and parameter values

10: Set button

- Setting of the parameter values (continuously by keeping the button pressed; incrementally by pressing the button once).
- Change between cm/inch indication and percent indication in the normal operating mode (Run mode).

11: Mode/Enter button

- Selection of the parameters and acknowledgement of the parameter values.

9 Menu

9.1 Menu structure

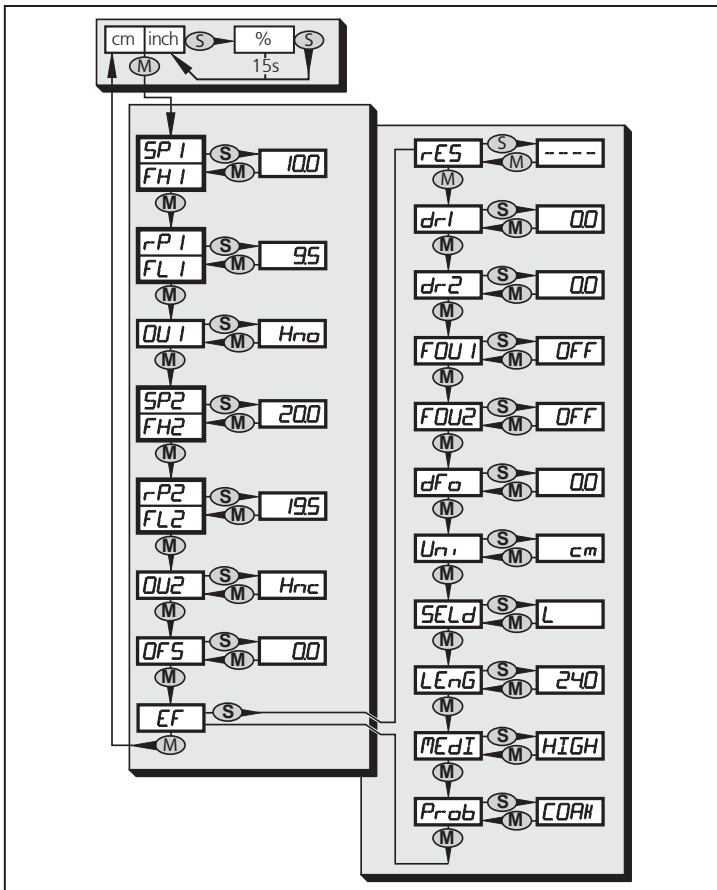

9.2 Explanation of the menu

SP1/rP1	Upper / lower limit value for the level at which OUT1 switches.
FH1/FL1	Upper / lower limit for the acceptable range (monitored by OUT1).
SP2/rP2	Upper / lower limit value for the level at which OUT2 switches.
FH2/FL2	Upper / lower limit for the acceptable range (monitored by OUT2).
OUx	Output function for OUTx: <ul style="list-style-type: none"> Switching signal for the level limit values: hysteresis function [H ..] or window function [F ..], either normally open [. no] or normally closed [. nc].
OFS	Offset value for level measurement
EF	Extended functions / opening of menu level 2.
rES	Restore factory setting.
dr1	Switch-off delay for OUT1. The menu item is only active if OU1 = Hno or Hnc.
dr2	Switch-off delay for OUT2. The menu item is only active if OU2 = Hno or Hnc.
FOU1	Response of OUT1 in case of a fault.
FOU2	Response of OUT2 in case of a fault.
dFo	Delay time for switching response OUTx.
Uni	Unit of measurement (cm or inch).
SELd	Type of indication.
LEnG	Probe length.
MEdI	Medium to be detected.
Prob	Type of probe used (single probe or coaxial probe). The menu item is only active if MEdI = HIGH.



UK

10 Parameter setting

During parameter setting the unit remains in the operating mode internally. It continues to monitor with the existing parameters until the parameter setting has been completed.

10.1 Parameter setting in general

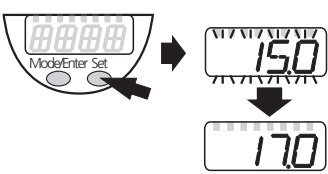
3 steps must be taken for each parameter setting:

1 Select parameter ▶ Press [Mode/Enter] until the requested parameter is displayed.	
2 Set parameter value ▶ Press [SET] and keep it pressed. > Current setting value of the parameter flashes for 5 s. > After 5 s: setting value is changed: incrementally by pressing the button once or continuously by keeping the button pressed.	
Numerical values are incremented continuously. For reducing the value: let the display move to the maximum setting value. Then the cycle starts again at the minimum setting value.	
3 Acknowledge parameter value ▶ Briefly press [Mode/Enter]. > The parameter is displayed again. The new setting value is saved.	
Setting of other parameters: ▶ Start again with step 1.	
Finishing the parameter setting: ▶ Press [Mode/Enter] several times until the current measured value is displayed or wait for 15 s. > The unit returns to the operating mode.	



If [S.Loc] is displayed → 11.1 Operating indicators.

- Change from menu level 1 to menu level 2:

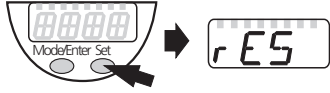
<ul style="list-style-type: none"> ▶ Press [Mode/Enter] until [EF] is displayed. 	
<ul style="list-style-type: none"> ▶ Briefly press [Set]. > The first parameter of the submenu is displayed (here: [res]). 	

- Locking / unlocking

UK

The unit can be locked electronically to prevent unintentional settings:

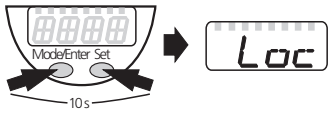
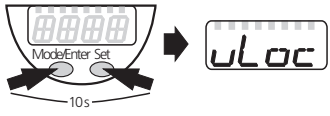
<ul style="list-style-type: none"> ▶ Make sure that the unit is in the normal operating mode. ▶ Press [Mode/Enter] + [Set] for 10 s. > [Loc] is displayed. 	
<p>During operation: > [Loc] is briefly displayed if you try to change parameter values.</p>	
<p>For unlocking:</p> <ul style="list-style-type: none"> ▶ Press [Mode/Enter] + [Set] for 10 s. > [uLoc] is displayed. 	

On delivery: not locked.

- Timeout:

If no button is pressed for 15 s during parameter setting, the unit returns to the operating mode with unchanged values.

10.2 Basic settings (unit on delivery)

On delivery of the unit, you must first enter the basic settings. The complete parameter setting menu cannot be accessed before this.

 Malfunctions may occur if wrong basic settings are entered.

10.2.1 Entering the probe length

<ul style="list-style-type: none">▶ Apply operating voltage.> The initial display $\equiv \equiv \equiv \equiv$ is shown.▶ Select [LEnG], press [SET] for 5 s.> [nonE] is displayed.▶ Enter the probe length in cm. Remarks on the determination of the probe length → 6.3.1 (single probes) or → 6.3.3 (coaxial probes).▶ Briefly press [Mode/Enter].	LEnG
--	-------------

10.2.2 Setting to the medium

<ul style="list-style-type: none">▶ Select [MEdI], press [SET] for 5 s.> [nonE] is displayed.▶ Set the requested value:<ul style="list-style-type: none">- [HIGH] for water and water-based media.- [LOW] for oils and oil-based media. <p>Note: In case of doubt, carry out an application test to ensure the setting which is best for your medium.</p>	MEdI
---	-------------

10.2.3 Entering the type of probe used

<ul style="list-style-type: none">▶ Select [Prob], press [SET] for 5 s.> [nonE] is displayed.▶ Set the requested value:<ul style="list-style-type: none">- [rod] for single probe.- [COAX] for coaxial probe.• The detection of water and water-based media is possible with the single probe as well as with the coaxial probe.• The detection of oils and oil-based media is only possible with the coaxial probe. Therefore, the parameter [Prob] is preset to [COAX] in case of the setting [MEdI] = [LOW]; the value [rod] is not available.	Prob
---	-------------

Then the unit changes to the operating mode. For further parameter setting the menu can be opened. The parameters [LEnG], [MEdI] and [Prob] can be accessed and modified just like all other parameters.



10.3 Configuration of the display

- ▶ Select [Uni] and set the unit of measurement: [cm], [inch].
Factory setting: cm.
- ▶ Select [SELD] and set type of indication:
 - [L] = The level is indicated in cm or inch.
 - [L%] = The level is indicated in percent of the final value of the measuring range.
 - [OFF] = The display is switched off in the operating mode. When one of the buttons is pressed, the current measured value is displayed for 15 s. The LEDs remain active even if the display is deactivated.

Uni
SELD

UK

10.4 Offset setting

- ▶ Select [OFS] and enter the distance between bottom of the tank and lower edge of the probe.
Afterwards, display and switch points refer to the real level.
Factory setting: [OFS] = 0.
Note: Set [OFS] before setting the switching limits (SPx/FHx, rPx/FLx).
Otherwise, the switching limits shift by the value of the set offset.

OFS

10.5 Setting of output signals

10.5.1 Setting of the output function

- ▶ Select [OU1] / [OU2] and set the switching function:
 - [Hno] = hysteresis function/NO,
 - [Hnc] = hysteresis function/NC,
 - [Fno] = window function/NO,
 - [Fnc] = window function/NC.

Note: If the upper switch point is used as an overflow protection, the setting OUx = Hnc (NC function) is recommended. The principle of normally closed operation ensures that wire break or cable break is also detected.

OU 1
OU 2

10.5.2 Set the switching limits (hysteresis function)

- ▶ Make sure that for [OU1] or [OU2] the function [Hno] or [Hnc] is set.
- ▶ Select [SP1] / [SP2] and set the value at which the output switches.

SP 1
SP 2





<p>▶ Select [rP1] / [rP2] and set the value at which the output resets. rPx is always smaller than SPx. The unit only accepts values which are lower than the value for SPx.</p>	<p>rP1 rP2</p>
--	--------------------

10.5.3 Set the switching limits (window function)

<p>▶ Make sure that for [OU1] or [OU2] the function [Fno] or [Fnc] is set. ▶ Select [FH1] / [FH2] and set the upper limit of the acceptable range.</p>	<p>FH1 FH2</p>
<p>▶ Select [FL1] / [FL2] and set the lower limit of the acceptable range. FLx is always lower than FHx. The unit only accepts values which are lower than the value for FHx.</p>	<p>FL1 FL2</p>

10.5.4 Setting of the switch-off delay

<p>▶ Select [dr1] / [dr2] and set the value between 0.2 and 60 s. At 0.0 (= factory setting) the delay time is not active. The switch-off delay is only active if hysteresis has been set as switching function (OUx = Hno or Hnc).</p>	<p>dr1 dr2</p>
---	--------------------

10.5.5 Response of the outputs in case of a fault

<p>▶ Select [FOU1] / [FOU2] and set the value: [on] = output switches ON in case of a fault. [OFF] = output switches OFF in case of a fault. Factory setting: [FOU1] and [FOU2] = [OFF]. Faults: Faulty hardware, too low a signal quality, untypical level curve. Overflow is not considered to be a fault.</p>	<p>FOU1 FOU2</p>
--	----------------------

10.5.6 Setting of the delay time after signal loss

<p>▶ Select [dFo] and set a value between 0.2 and 5.0 s. At 0.0 (= factory setting) the delay time is not active. Mind the dynamics of your application. In case of fast level changes it is recommended to adapt the value step by step.</p>	<p>dFo</p>
---	------------

10.6 Reset all parameters to factory setting

<p>▶ Select [rES], then press [Set] and keep it pressed until [---] is displayed. ▶ Briefly press [Mode/Enter]. > The unit reboots and the factory settings are restored. Note: On delivery the unit is not operational. First, the basic settings must be entered (→ 10.2).</p>	<p>rES</p>
---	------------



10.7 Changing basic settings

Required after changes to the probe or to the application area.

10.7.1 Re-enter the probe length

<ul style="list-style-type: none">▶ Change to menu level 2▶ Select [LEnG] and set probe length L. Note the set unit of measurement (cm or inch). Step increment: 0.5 cm / 0.2 inch. <p>Remarks on the determination of the probe length:</p> <ul style="list-style-type: none">▶ Note the remarks → 6.3.1 (single probes) or → 6.3.3 (coaxial probes).▶ Briefly press [Mode/Enter]. <p>Note: After changing the probe length, the values for OFS and the switching limits must also be reviewed / re-entered.</p>	LEnG
---	-------------

UK

10.7.2 Setting to another medium

<ul style="list-style-type: none">▶ Select [MEdI] and set the value:<ul style="list-style-type: none">- [HIGH] for water and water-based media.- [LOW] for oils and oil-based media. <p>Note: In case of doubt, carry out an application test to ensure the setting which is best for your medium.</p>	MEdI
---	-------------

10.7.3 New entering of the type of probe used

<ul style="list-style-type: none">▶ Select [Prob] and set the value:<ul style="list-style-type: none">- [rod] for single probe.- [COAX] for coaxial probe.• The detection of water and water-based media is possible with the single probe as well as with the coaxial probe.• The detection of oils and oil-based media is only possible with the coaxial probe. Therefore, the parameter [Prob] is not available in case of the setting [MEdI] = [LOW] (the value [COAX] is preset).	Prob
---	-------------

11 Operation

After power on, the unit is in the Run mode (= normal operating mode). It carries out its measurement and evaluation functions and generates output signals according to the set parameters.

11.1 Operating indicators

Numerical value + LED 1	Current level in cm.
Numerical value + LED 2	Current level in inch.
Numerical value + LED 3	Current level in % of the final value of the measuring range.
LED 7 / LED 8	Switching status of the corresponding output.
[----]	Level below the active zone.
[FULL] + numerical value alternately	Level has reached or exceeded the maximum measuring range (= overflow warning).
[CAL]	Initialisation phase after power on
≡≡≡	On delivery the unit is not operational. Basic settings required (→ 10.2).
[Loc]	Unit electronically locked; parameter setting impossible. For unlocking press the two setting buttons for 10 s.
[uLoc]	Unit is unlocked / parameter setting is possible again.
[S.Loc]	If [S.Loc] is displayed when an attempt is made to modify a parameter value, either an IO-Link communication is active (temporary locking) or the sensor is permanently locked via software. This locking can only be removed with a parameter setting software.

11.2 Read the set parameters

- ▶ Briefly press [Mode/Enter] to scroll the parameters.
- ▶ Briefly press [Set] to indicate the corresponding parameter value for about 15 s. After another 15 s the unit returns to the Run mode.

11.3 Changing the display unit in the Run mode

(= switching between length indication (cm / inch) and percentage)

- ▶ Briefly press [Set] in the Run mode.
- > The selected unit is displayed for 15 s, the corresponding LED is lit. With each push of the button the display type is changed.

11.4 Error indications

	Possible cause	Recommended measures
[E.000]	Fault in the electronics.	Replace the unit.
[E.031]	Probe detached from the unit; possibly incorrect setting of the probe length.	Check whether the probe is still attached to the unit. Check the parameter [LEnG].
[E.033]	Measurement disturbed by heavy foam formation or strong turbulence.	<ul style="list-style-type: none"> • Install the unit in a still pipe or bypass. • Set or increment [dFo] (→ 10.5.6).
	Measurement disturbed by separation layers (e.g. oil layer on water).	Remove the oil layer by suction, stir the medium, verify the composition.
	Rod or process connection soiled.	Clean the rod and the process connection, carry out a reset.**
	Installation conditions were not adhered to.	Observe the notes in "Installation" (→ 6).
	Probe length, type of probe or sensitivity (setting to the medium) is incorrect.	Correct the settings (→ 10.2), then carry out a reset.**
[E.034]	Atypical, abrupt level changes.*	Check the dynamics (if necessary, use a still pipe or bypass), then carry out a reset.**
[SCx]	Flashing: short circuit in switching output x.	Remove the short circuit.
[SC]	Flashing: short circuit in all switching outputs.	Remove the short circuit.
[PArA]	Faulty data set	Reset to factory settings (→ 10.6).

* The unit carries out plausibility checks to increase the operational reliability. Atypical level changes can be caused e.g. by heavy soiling or strong turbulence. With the parameter [dFo] the response of the unit can be delayed (→ 10.5.6).

** Carry out a reset (power off and on again) after rectifying the fault to reset the error message.

11.5 Output response in different operating states

	OUT1	OUT2
Initialisation	OFF	OFF
Normal operation	according to the level and OU1 setting	according to the level and OU2 setting
Fault (E.0xx)	OFF for FOU1 = OFF; ON for FOU1 = on	OFF for FOU2 = OFF; ON for FOU2 = on

12 Technical data and scale drawing



Technical data and scale drawing at www.autosen.com.

12.1 Setting ranges

[LEnG]	cm	inch
Setting range	10...160	4.0...63
Step increment	0.5	0.2

[OFS]	cm	inch
Setting range	0...100	0...39.4
Step increment	0.5	0.2

The setting ranges for the switching limits (SPx, rPx, FHx, FLx) depend on the probe length (L). In general the following applies:

	cm		inch	
	min	max	min	max
SPx / FHx	1.5 (3.5)	L - 3	0.6 (1.4)	L - 1.2
rPx / FLx	1.0 (3.0)	L - 3.5	0.4 (1.2)	L - 1.4
Step increment	0.5		0.2	

The values apply if [OFS] = 0. The values in brackets apply to the setting [MEdI] = [LOW] (setting for the detection of oils and oil-based media).

- rPx (FLx) is always smaller than SPx (FHx). If the value for SPx (FHx) is reduced to a value \leq rPx (FLx), the position of rPx (FLx) also shifts.
- If rPx (FLx) and SPx (FHx) are close together (approx. 3 x step increment), rPx (FLx) is changed automatically when SPx (FHx) is increased.
- If there is a greater distance between rPx (FLx) and SPx (FHx), rPx (FLx) maintains the set value even if SPx (FHx) is increased.



13 Servicing

- ▶ Keep the process connection free of deposits and foreign bodies.
- ▶ In case of heavy soiling: clean the process connection and the probe at regular intervals.

In case of longer operation separation layers can form in the medium (e.g. oil on water). This applies especially to still pipes or bypasses:

- ▶ Remove separation layers at regular intervals.
- ▶ Ensure that the vent hole (at the upper end of the coaxial pipe) remains free.
- ▶ Keep the interior of the coaxial pipe free from foreign bodies and soiling.

UK



14 Applications

14.1 Minimum level monitoring with early warning and alarm

Switching output 1: early warning	
SP1	slightly above rP1 (to suppress wave movements)
rP1	below preset level → early warning, start refilling
OU1	hysteresis function, normally closed (Hnc)
Switching output 2: Alarm	
SP2	min. value reached again → alarm reset
rP2	below min. value → alarm
OU2	Hysteresis function, normally open (Hno)

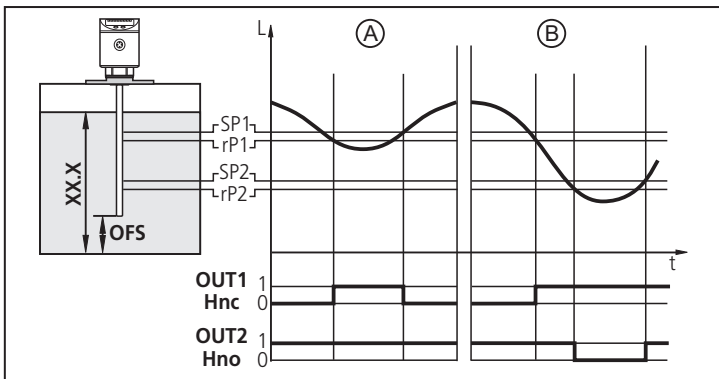

XX.X = display value

A = early warning

B = alarm

- If the level is below rP1, output 1 switches until liquid is refilled. If SP1 is reached again, output 1 switches off.
- If the level is above SP2, output 2 switches. If the level falls below rPs or if there is a wire break, output 2 switches off.
- By setting SP1 the maximum level can be controlled / monitored: the value of SP1 determines up to which level (max.) is to be refilled. When the maximum level is reached, this is signalled by the LED OUT1 going out and output 1 switching off.

14.2 Pumping station / empty the tank with overflow protection

Switching output 1: control to empty tank	
SP1	upper value exceeded → submersible pump ON
rP1	lower value reached → submersible pump OFF
OU1	hysteresis function, normally open (Hno)
Switching output 2: overflow protection	
SP2	maximum value exceeded → alarm
rP2	slightly below SP2 (to suppress wave movements)
OU2	hysteresis function, normally closed (Hnc)

UK

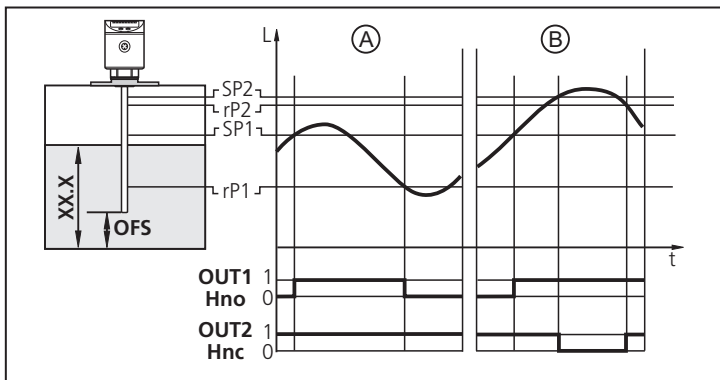

XX.X = display value

A = emptying

B = overflow protection

- If SP1 is exceeded, output 1 switches (submersible pump ON). If the level is below rP1 again output 1 switches off (submersible pump OFF).
- If SP2 is exceeded or if there is a wire break, output 2 switches off.

14.3 Storage tank

Monitoring of the acceptable range (alarm) and level control

Switching output 1: refilling	
SP1	upper preset value reached → finish refilling
rP1	below lower preset value → start refilling
OU1	hysteresis function, normally closed (Hnc)
Switching output 2: safety function min - max	
FH2	max. value exceeded → alarm
FL2	below min. value → alarm
OU2	window function, normally open (Fno)

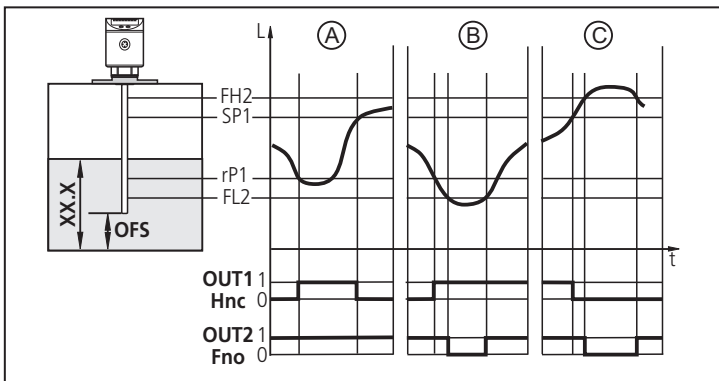

XX.X = display value

A = refill; B = min. monitoring; C = max. monitoring

- If the level is below rP1, output 1 switches until liquid is refilled. If SP1 is reached again, output 1 switches off.
- If the level is below FL2 or above FH2 or if there is a wire break, output 2 switches OFF (→ alarm).
- The logical operation between the outputs 1 and 2 indicates whether there is overflow or the actual level is below the minimum level:
 - Overflow: output 1 and output 2 switched OFF.
 - Below min. value: output 1 switched ON and output 2 switched OFF.

15 Factory setting

	Factory setting	User setting
SP1 / FH1	50% SP/FHmax	
rP1 / FL1	50% rP/FLmax	
OU1	Hno	
SP2 / FH2	100% SP/FHmax	
rP2 / FL2	100% rP/FLmax	
OU2	Hnc	
OFS	0.0	
dr1	0.0	
dr2	0.0	
FOU1	OFF	
FOU2	OFF	
dFo	0	
Uni	cm	
SELD	L	
LEnG	nonE	
MEdl	nonE	
Prob	nonE	

UK

SP/FHmax = LEnG value minus 3.

rP/FLmax = LEnG value minus 3.5.

When the LEnG value is entered, the program calculates the basic setting.

Technical data and further information at:

www.autosen.com