

1"

178 l/min

**PRO
Series**







1" non-metallic diaphragm pump

Pompe non-métallique à membranes 1"

Bomba no metálica de membrana, 1"

Pompa non metallica a membrana da 1"

Specifications – Especificaciones – Caratteristiche

	1:1
	178 l/min
	0.64 litre
	8.3 bar (120 psi)
	3.2 mm
	4.60 m
	6661A3-, 1AF-, 1AJ-, 1AL- 9.2 kg 6661A4-, 1AG-, 1AK-, 1AN- 12.9 kg 6661B3-, 1BF-, 1BJ-, 1BL- 13.1 kg 6661B4-, 1BG-, 1BK-, 1BN- 16.8 kg



6661AJ-3EB-C



6661A3-244-C

Ordering menu • Codification • Codificación • Informazioni per l'ordinazione

Center section Partie moteur Sección central Sezione centrale	Fluid Caps / manifold material Matériau partie mouillée / raccordement Material de las tapas de fluido / conexión Materiale tappi fluido / collettore	Seat material Matière siège Material asiento Materiale sede	Ball material Matière bille Material bola Materiale sfera	Diaphragm Membrane Membrana Membrana	
A Aluminium B Cast iron Fonte Hierro fundido Ghisa	3 Polypropylene, ANSI / DIN flange (3-piece manifold) Polypropylene, bride ANSI / DIN (collecteur en 3 parties) Polipropileno, brida ANSI / DIN (colector de 3 piezas) Polipropilene, collettore ANSI (in 3 pezzi) 4 PVDF, ANSI / DIN flange (3-piece manifold) PVDF, bride ANSI / DIN (collecteur en 3 parties) PVDF, brida ANSI / DIN (colector de 3 piezas) PVDF, collettore ANSI / DIN (in 3 pezzi) F Polypropylene, ANSI / DIN flange (1-piece manifold) Polypropylene, bride ANSI / DIN (collecteur en 1 partie) Polipropileno, brida ANSI / DIN (colector de 1 pieza) Polipropilene, collettore ANSI / DIN (in 1 pezzo) G PVDF, ANSI / DIN flange (1-piece manifold) PVDF, bride ANSI / DIN (collecteur en 1 partie) PVDF, brida ANSI / DIN (colector de 1 pieza) PVDF, collettore ANSI / DIN (in 1 pezzo) J Polypropylene / NPT tread (1-piece manifold) Polypropylene / Filetage NPT (collecteur en 1 partie) Polipropileno / Rosca NPT (colector de 1 pieza) Polipropilene / Filetto NPT (in 1 pezzo) K PVDF / NPT tread (1-piece manifold) PVDF / Filetage NPT (collecteur en 1 partie) PVDF / Rosca NPT (colector de 1 pieza) PVDF / Filetto NPT (in 1 pezzo) L Polypropylene / BSP tread (1-piece manifold) Polypropylene / Filetage BSP (collecteur en 1 partie) Polipropileno / Rosca BSP (colector de 1 pieza) Polipropilene / Filetto BSP (in 1 pezzo) N PVDF / BSP tread (1-piece manifold) PVDF / Filetage BSP (collecteur en 1 partie) PVDF / Rosca BSP (colector de 1 pieza) PVDF / Filetto BSP (in 1 pezzo)	2 316 Stainless steel Inox 316 Acero inox. 316 Acciaio inox 316 3 Polypropylene 4 PVDF 8 Hard 400 stainless steel Acier inox 400 traité dur 400 Acero Inox. (duro) 400 Acciaio inox (duro)	3 Viton® 4 PTFE 8 Polyuretane A 316 Stainless steel C Hytrel® E Santoprene®	3 Viton® 4 PTFE / Santoprene® 6 PTFE 1 piece diaphragm Membrane monobloc PTFE Membrana de una pieza en PTFE Membrana PTFE in un unico pezzo 9 Hytrel® B Santoprene®	C Revision 3 Révision 3 Revisión 3 Revisione 3

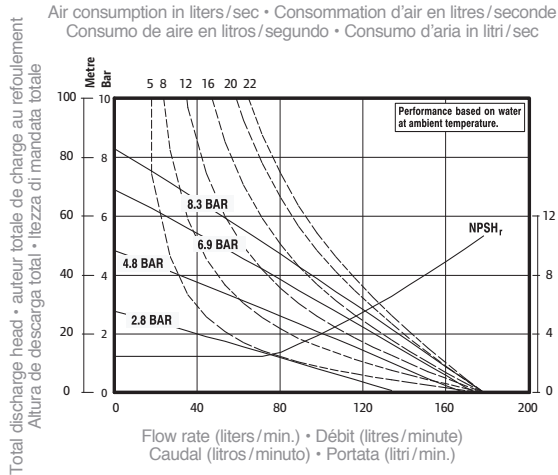

NPSH required in meters • NPSH requis en mètres
NPSH necesario en metros • PSH richiesta in metri

Dimensions • Dimensiones • Dimensioni

Model	6661X3-X	6661X4-X	6661XJ-X 6661XL-X
A (mm)	321	316	334
B	349	345	350
C	255	252	255
D	60	59	59
E	204	201	204
F	406	400	376
G	128	126	128
H	160	157	160
K	23	23	51
L	57	56	-
N	80	79	-

Model	6661XK-X 6661XN-X	6661XF-X	6661XG-X
A (mm)	331	334	331
B	345	350	345
C	252	255	252
D	59	59	59
E	201	204	201
F	371	406	401
G	126	128	126
H	157	160	157
K	50	26	25
N	-	80	79

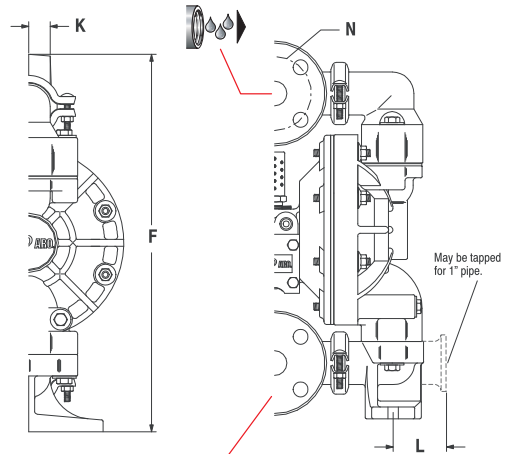

6661X3-X, 6661X4-X,
6661XF-X, 6661XG-X : 1" A.N.S.I./DIN Flange

Pump accessories • Accessoires pour la pompe • Accesorios para bomba • Accessori per pompe

P39224-610	Filter / Regulator Piggyback – 1/4" NPT – 0 to 10 bar – filter element 5µ – metallic bowl with sight glass – gauge – manual drain Filtre / régulateur – 1/4" NPT – 0 à 10 bar – élément filtrant 5µ – bol métallique avec regard – manomètre – purge manuelle Filtro / regulador – 1/4" NPT – 0 a 10 bar – elemento filtrante 5 µ – vaso de metal con mirilla – manómetro – drenaje manual Filtro / regolatore – 1/4" NPT – 0 a 10 bar – elemento filtro 5 µ – coppa metallica con spia – manometro – drenaggio manuale
P39224-614	Filter / Regulator Piggyback – 1/4" NPT – 0 to 10 bar – filter element 5µ – metallic bowl with sight glass – gauge – automatic drain Filtre / régulateur – 1/4" NPT – 0 à 10 bar – élément filtrant 5µ – bol métallique avec regard – manomètre – purge automatique Filtro / regulador – 1/4" NPT – 0 a 10 bar – elemento filtrante 5 µ – vaso de metal con mirilla – manómetro – drenaje automático Filtro / regolatore – 1/4" NPT – 0 a 10 bar – elemento filtro 5 µ – coppa metallica con spia – manometro – drenaggio automatico
67078	ANSI/DIN flange connection kit – glass-filled polypropylene – stainless steel nuts – gasket is 4401 klinger synthetic fiber nitrile binder. Kit de raccordement pour bride ANSI/DIN – polypropylène vitrifié – visserie en acier inox – joint fibre synthétique Klinger 4401 / liant nitrile Kit de conexión fluido para brida ANSI / DIN – polipropileno carga de vidrio – tornillos de acero inox. – junta en fibra sintética 4401 klinger / nitrilo. Kit di collegamento ANSI / DIN – polipropilene caricato con vetro – bulloneria in acciaio inox – guarnizione in fibra di nitrile sintetico 4401 klinger.
66975	Pneumatic cycle counter kit (see details page 77) Compteur de cycles pneumatique (voir description page 77) Contador de ciclos neumático (presentado en página 77) Contatore di cicli pneumatico (vedere pagina 77).
48495964	One piece diaphragm kit including composite PTFE diaphragms (PTFE-PA FABRIC-EPDM), connecting rod, end plate, o-ring, shim pack and grease package Kit membranes monobloc: mono membranes en PTFE composite (PTFE-PA FABRIC-EPDM), tige de connexion, plaque d'extrémité, joint torique, jeu de cales et graisse Juego de membranas de una pieza incluye diafragmas compuestos de PTFE (PTFE-PA FABRIC-EPDM), barra de conexión, plato, junta tórica, arandelas de ajuste y grasa Kit membrana in un pezzo – include: membrana in PTFE (PTFE-PA-EPDM), connessione asta, piattello, o-ring, spessori e grasso
637118-C	Service repair kit for air section Kits de réparation, section pneumatique Kit de reparación, sección de aire Kit di riparazione, sezione pneumatica
637161-XX-C	Service repair kit for fluid section Kits de réparation, section fluide Kit de reparación, sección de fluido Kit di riparazione, sezione fluidi